

Technical data sheet

Height compensation set for UZD350-3 with height 165–220 mm

Item number: 7410164

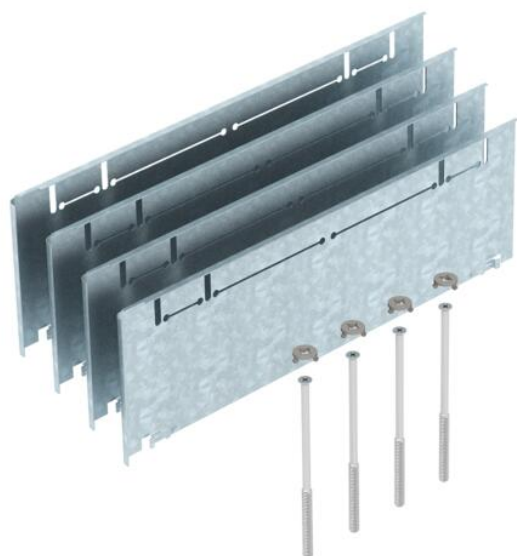

Height compensation set for underfloor boxes UZD350-3 with a construction height of 165 to 220 mm, consisting of four fall plates, four height adjustment screws and four rotary locks.



St Steel

FS Strip galvanized

Master data

Item number	7410164
Type	ASH350-3 215270
Description 1	Height construction set
Description 2	for screed height 215+55mm
Manufacturer	OBO
Material	Steel
Surface	Strip galvanized
Surface standard	DIN EN 10346
Smallest sales unit	1
Unit of quantity	Piece
Weight	105 kg
Weight unit	kg/100 pc.

Technical data sheet

Height compensation set for UZD350-3 with height 165–220 mm

Item number: 7410164



Dimensions



Dimension A	430 mm
Dimension B	80 mm
Dimension I	212 mm

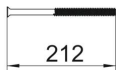
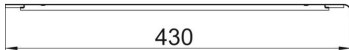

Technical data

Version for	Square
Floor plate	no
Lowerable to be flush-floor	no
Seal installation option	no
Installation opening for on-floor tank	no
Decouplable	no
Screed height, max.	270 mm
Screed height, min.	215 mm
For pipe connection	no
Suitable for raised floor installation	no
Suitable for screed-flush closed underfloor ducts	no
Suitable for screed-covered underfloor ducts	yes
Suitable for cavity floor installation	no
Suitable for underfloor ducts	no
Trunking width, max.	350 mm
Trunking width, min.	250 mm
Height-adjustment range, max.	270 mm
Height-adjustment range, min.	215 mm